

Section-B

TCP/IP PROTOCOL SUITE

Section-B TCP/IP PROTOCOL SUITE

The layers in the *TCP/IP protocol suite* do not exactly match those in the OSI model. The original TCP/IP protocol suite was defined as having four layers: *host-to-network*, *internet*, *transport*, and *application*. However, when TCP/IP is compared to OSI, we can say that the TCP/IP protocol suite is made of five layers: *physical*, *data link*, *network*, *transport*, and *application*.

Topics discussed in this section:

Physical and Data Link Layers

Network Layer

Transport Layer

Application Layer

TCP/IP and OSI model

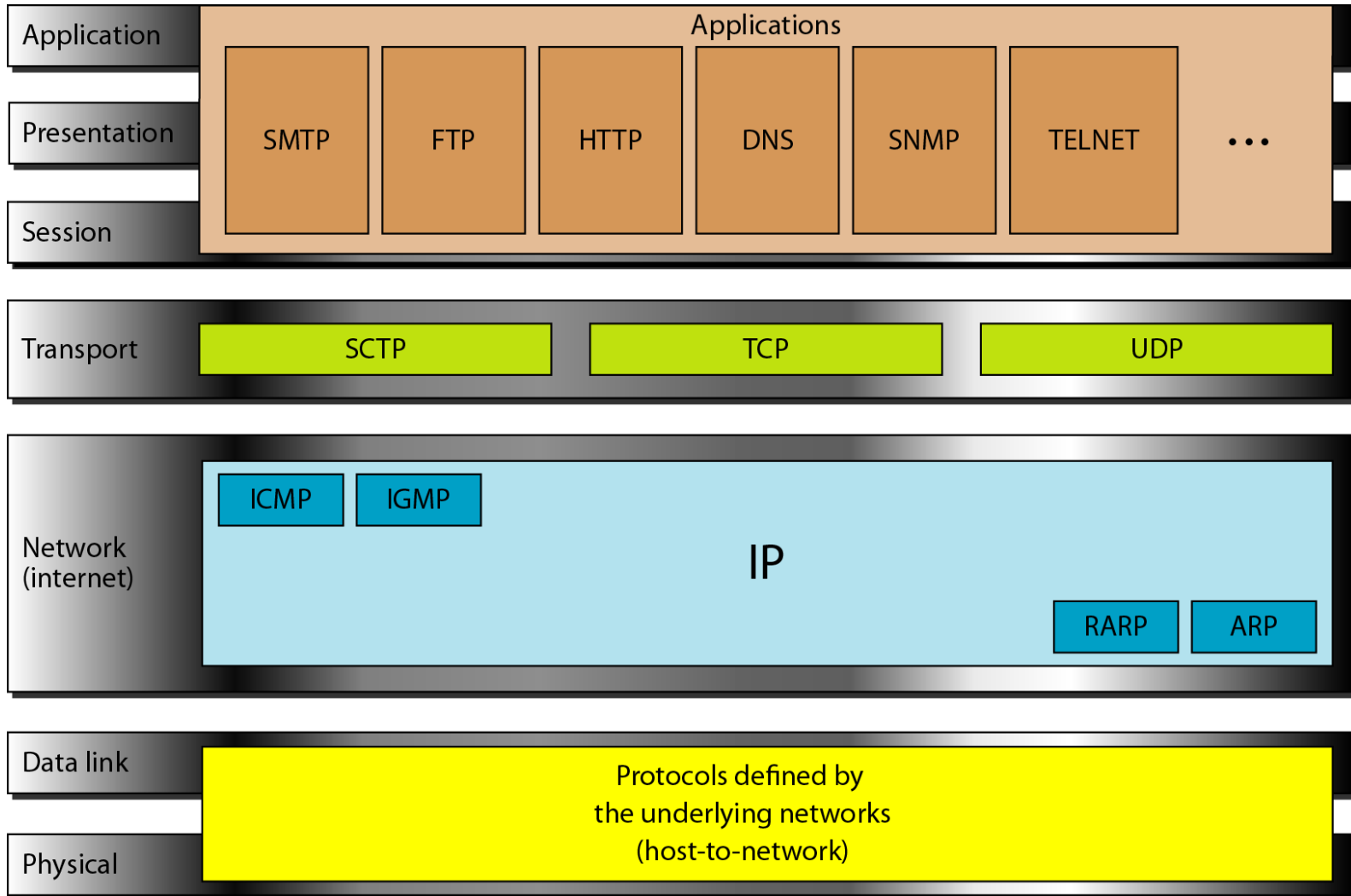

ADDRESSING

*Four levels of addresses are used in an internet employing the TCP/IP protocols: **physical**, **logical**, **port**, and **specific**.*

Topics discussed in this section:

Physical Addresses

Logical Addresses

Port Addresses

Specific Addresses

Addresses in TCP/IP

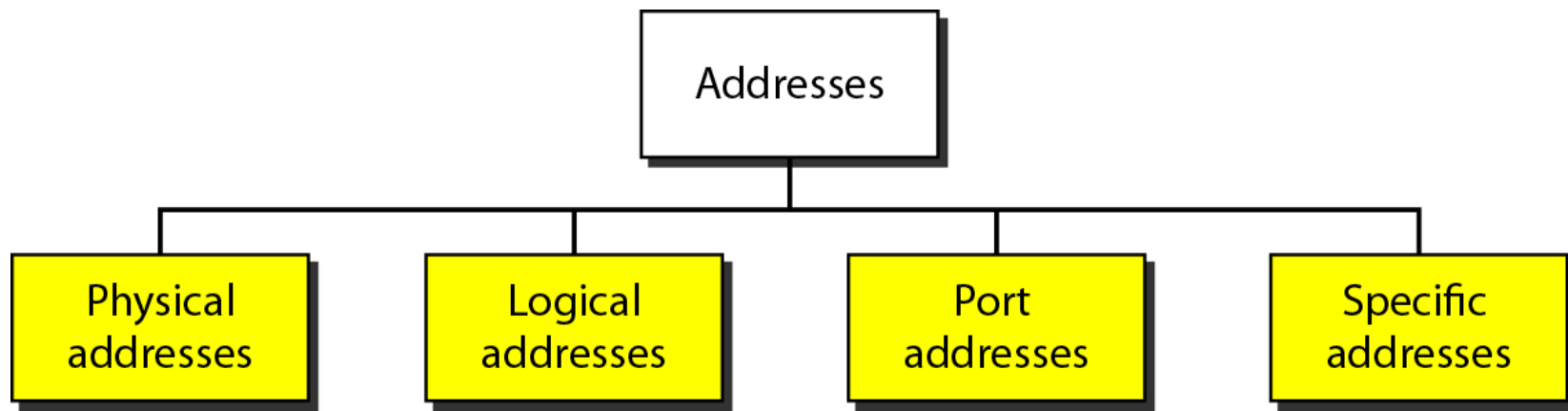

Relationship of layers and addresses in TCP/IP

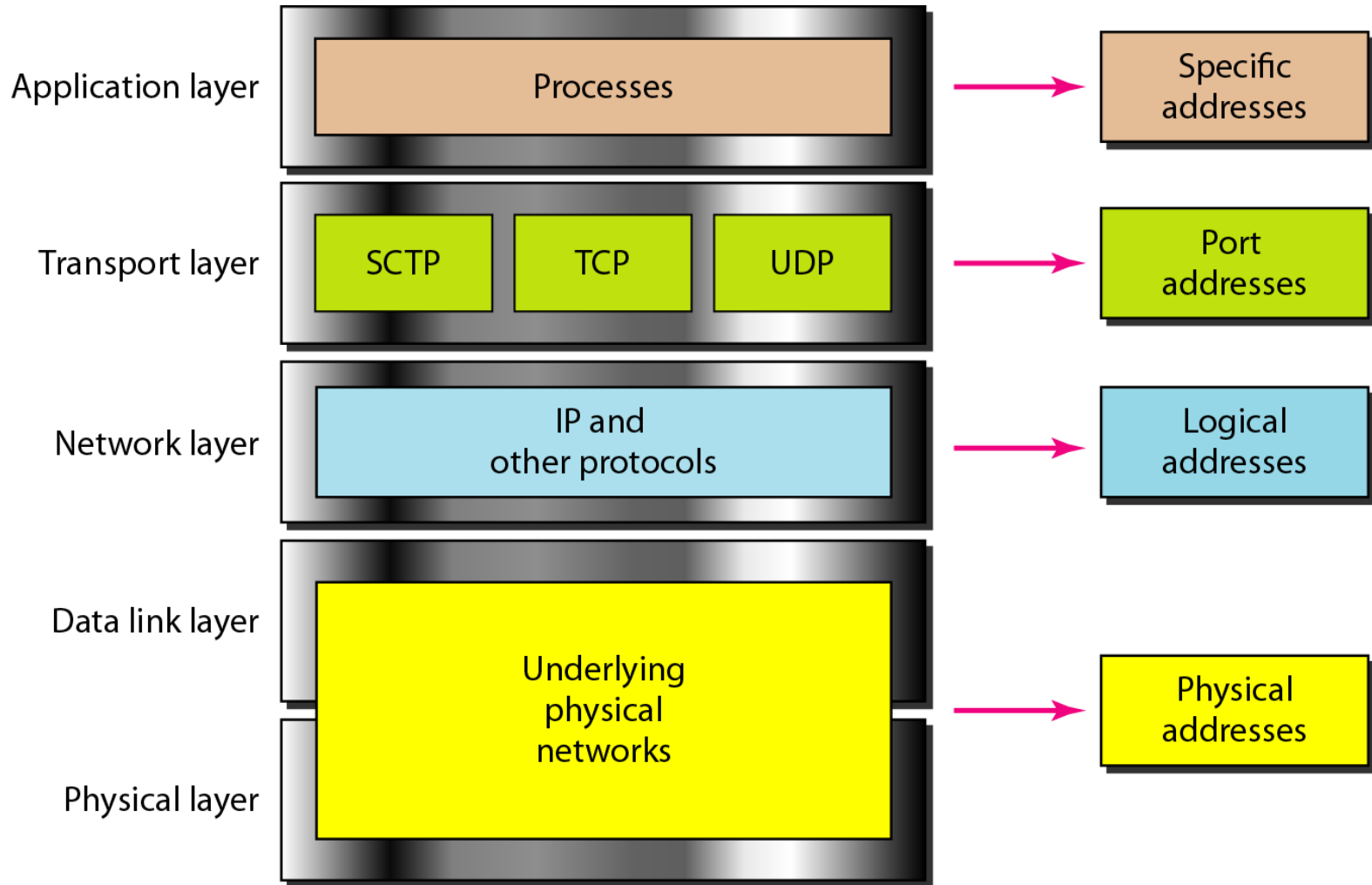



Example Physical Address

In Figure a node with physical address 10 sends a frame to a node with physical address 87. The two nodes are connected by a link (bus topology LAN). As the figure shows, the computer with physical address 10 is the sender, and the computer with physical address 87 is the receiver.

Figure Physical addresses

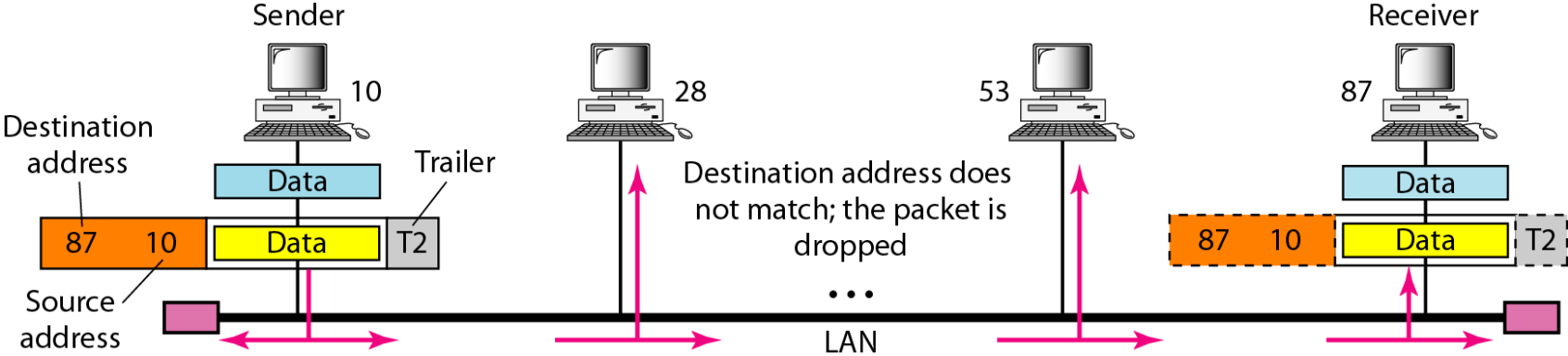



Example physical Address

Most local-area networks use a 48-bit (6-byte) physical address written as 12 hexadecimal digits; every byte (2 hexadecimal digits) is separated by a colon, as shown below:

07:01:02:01:2C:4B

A 6-byte (12 hexadecimal digits) physical address.



Example logical Address

Figure shows a part of an internet with two routers connecting three LANs. Each device (computer or router) has a pair of addresses (logical and physical) for each connection. In this case, each computer is connected to only one link and therefore has only one pair of addresses. Each router, however, is connected to three networks (only two are shown in the figure). So each router has three pairs of addresses, one for each connection.

Figure IP addresses

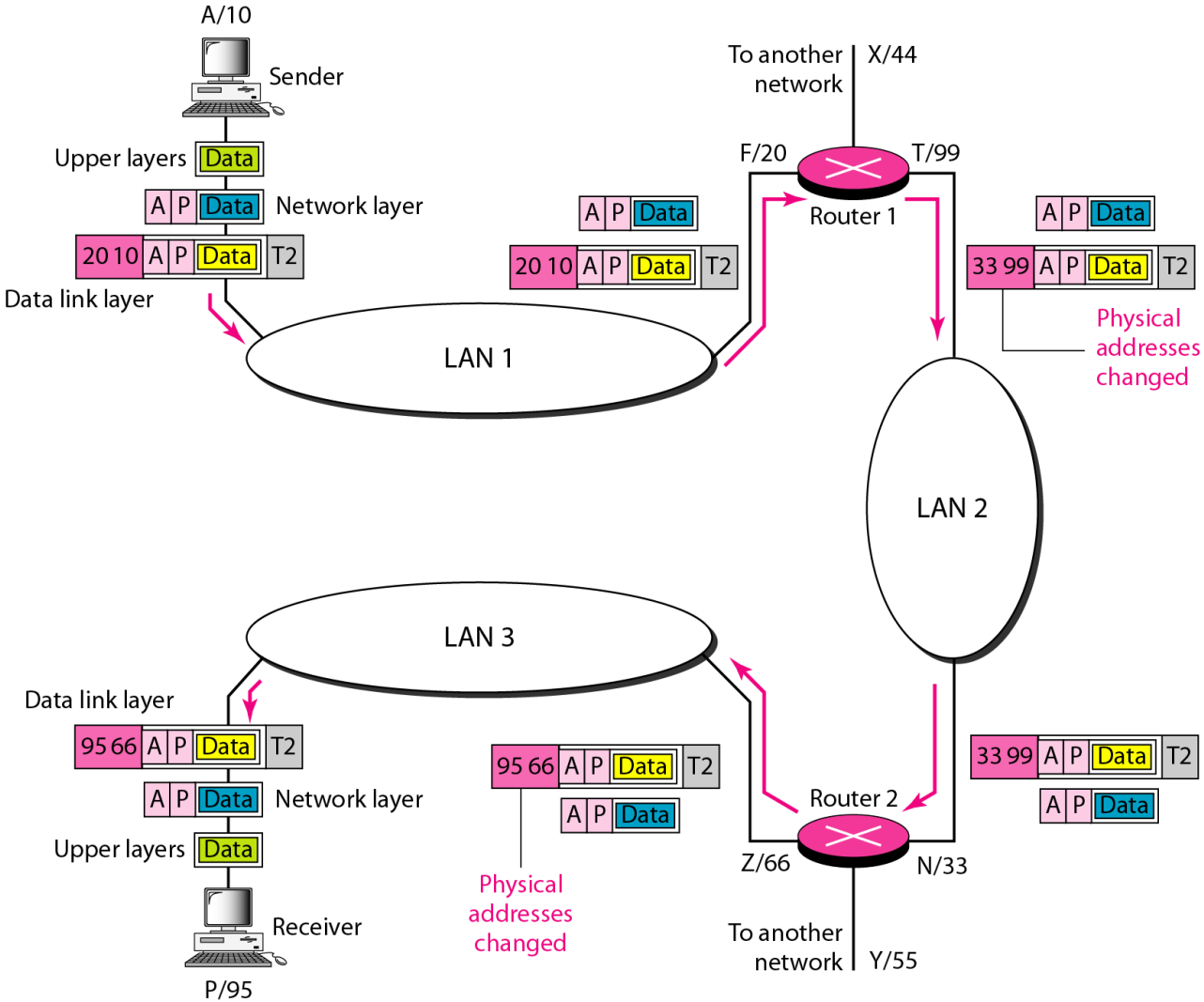





Example Port Address

Figure shows two computers communicating via the Internet. The sending computer is running three processes at this time with port addresses a, b, and c. The receiving computer is running two processes at this time with port addresses j and k. Process a in the sending computer needs to communicate with process j in the receiving computer. Note that although physical addresses change from hop to hop, logical and port addresses remain the same from the source to destination.

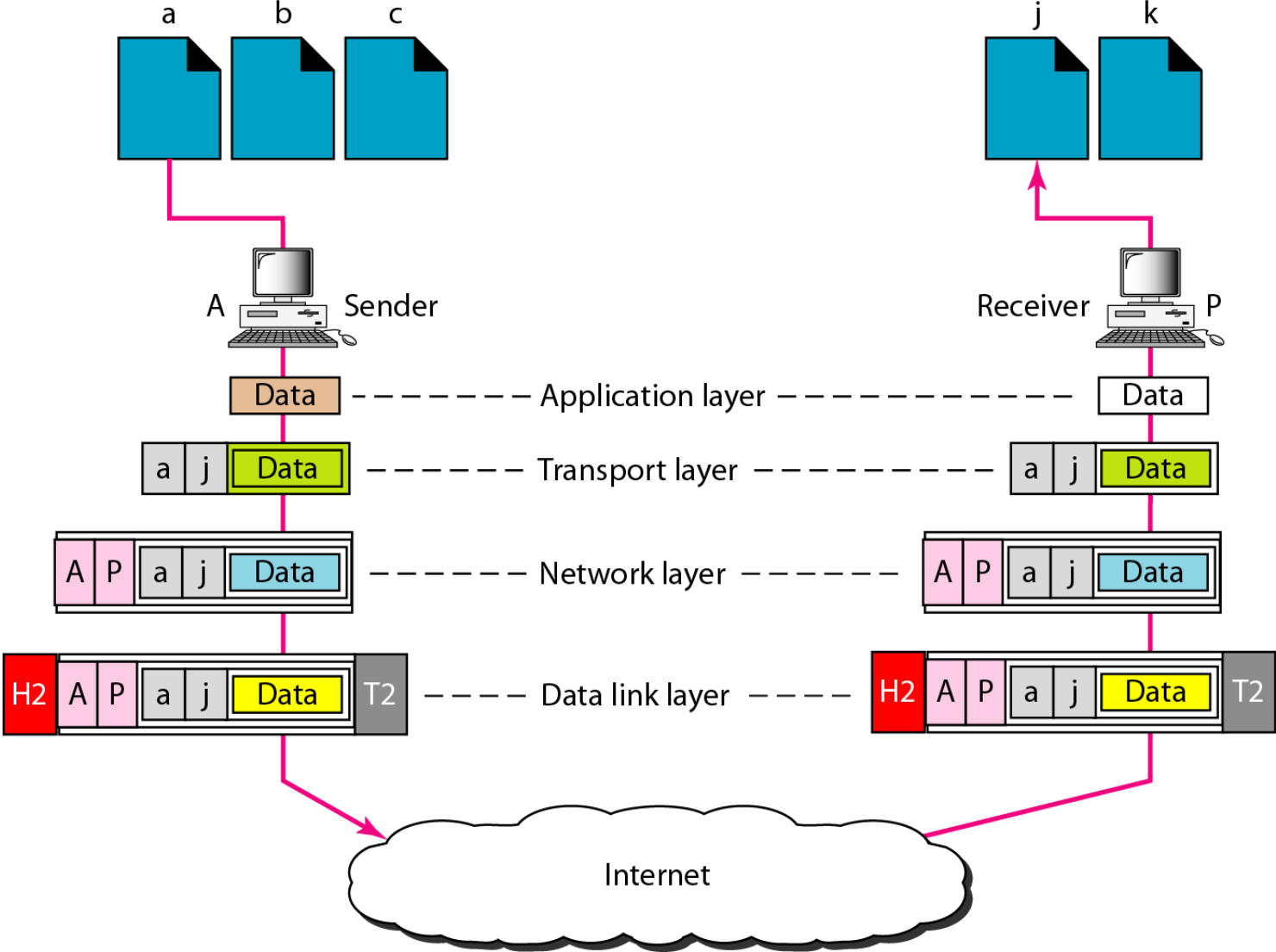
Figure Port addresses





The physical addresses will change from hop to hop,
but the logical addresses usually remain the same.



Example Port Address

A port address is a 16-bit address represented by one decimal number as shown.

753

A 16-bit port address represented
as one single number.



Note

The physical addresses change from hop to hop,
but the logical and port addresses usually remain the same.